

Spherical roller bearings, cylindrical and tapered bore

Principal dimensions			Basic load ratings		Speed ratings		Designation
d	D	B	dynamic C	static C0	Reference speed	Limiting speed	
mm			kN		r/min		
140	250	68	743	900	2400	3200	* SKF Explorer bearing 22228 CCK/W33 *

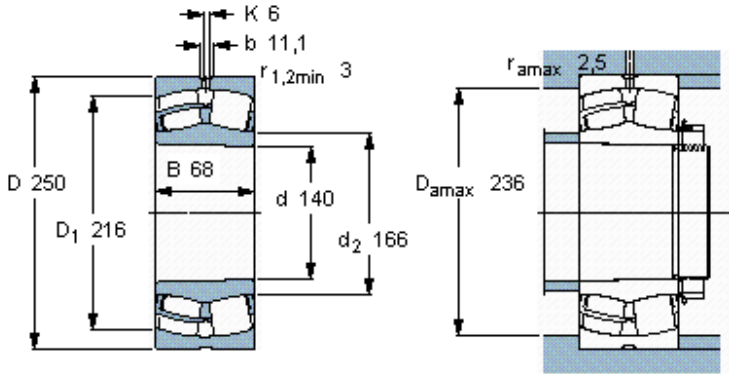

Tapered bore, taper
1: 12

Calculation factors

- e 0,26
- Y_1 2,6
- Y_2 3,9
- Y_0 2,5